

LOKKI 700

Asennusohje
V.14A

INNOLUX
design Yki Nummi

Osat:

2 x Kupu

Ripustussarjan tarvikkeet:

1 x Valaisinjohto



1 x Ripustuskoukku



1 x Valaisinpistotulppajohto



1 x Musta tiiviste, riviliitin



1 x Kattokuppi



1 x Ruuvimeisseli



1 x Kuulaketjupussi

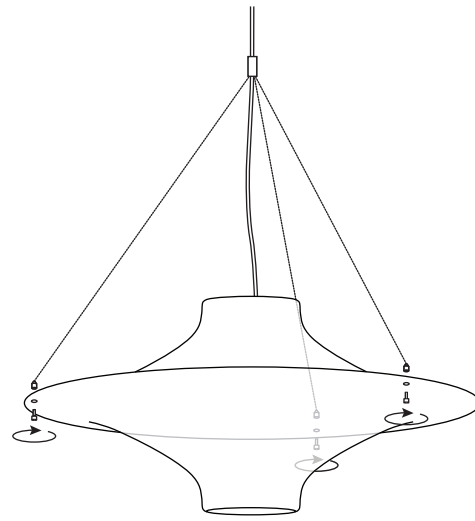
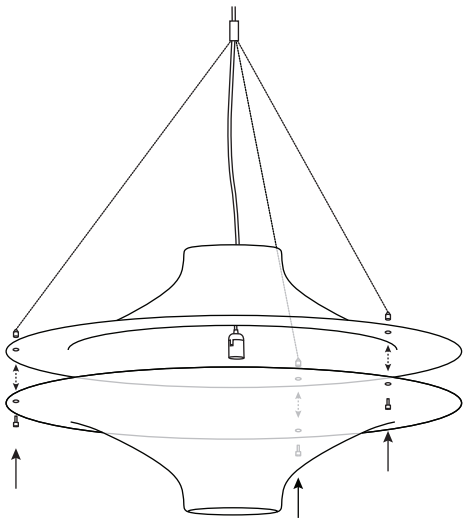

1 Aseta valaisimen akryylikuvut vastakkain toisiinsa, että kuvuissa olevat reiät osuvat kohdakkain.

Pyöritä ripustussarjan ketjujen päissä olevat sormiruuvit auki ja pujota ruuvit kupujen läpi alapuolelta.

Ruuvaa ruuvit kiinni kupujen yläpuolelle jääviin vastakappaleisiin. Tarkista, että ketjut ovat järjestyksessä. Paina akryylikupuja vastakkain ruuveja kiinnittäessäsi, jotta saat ne mahdollisimman tiukalle.

INNOLUX
Home of good light.

A Kattopistorasia:

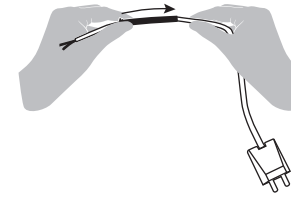

3 Pujota valaisinpistotulpan johto mustan tiivistein läpi.

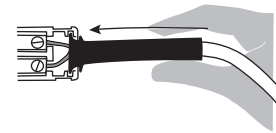

5 Siirrä musta tiiviste paikalleen.

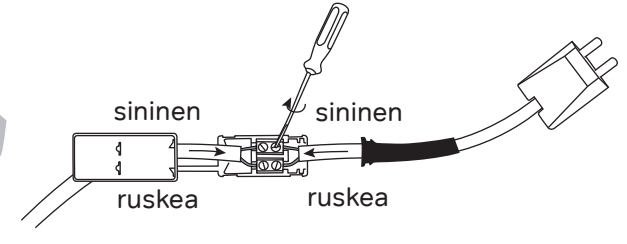

4 Avaa riviliittimen ruuvit, pujota molempien johtojen päät paikoilleen riviliittimeen ja kiristä ruuvit.

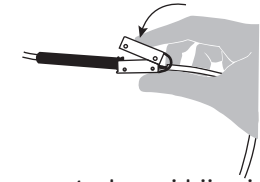

6 Napsauta kansi kiinni, varmista että kaikki neljä hakasta kiinnittyvät.

B Ei kattopistorasiaa:

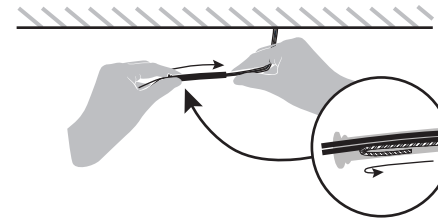

3 Taita keltavihreä katosta tuleva johto kaksinkerroin ja pujota kaikki katosta tulevat johtimet tiivistein läpi.

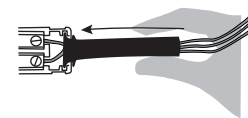

5 Siirrä musta tiiviste paikalleen.

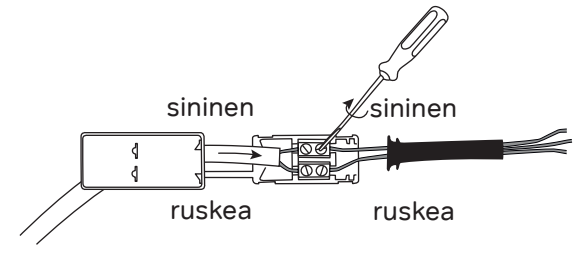

4 Avaa riviliittimen ruuvit, pujota valaisinjohton sekä katosta tulevien johtimien (ei keltavihreä johdin) päät riviliittimeen ja kiristä ruuvit.

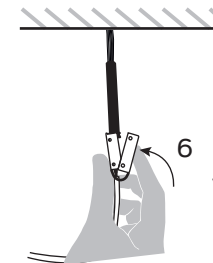

6 Napsauta kansi kiinni, varmista että kaikki neljä hakasta kiinnittyvät.

(A) Kattopistorasia:

1

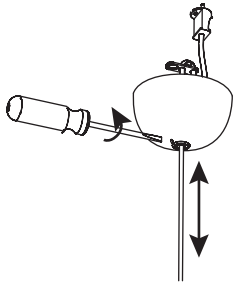

2

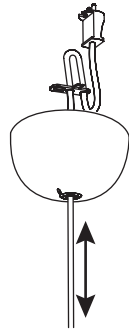

3

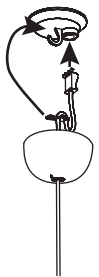

4

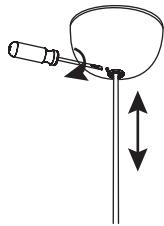

(B) Ei kattopistorasiaa:

1

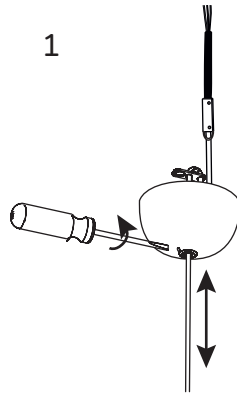

2

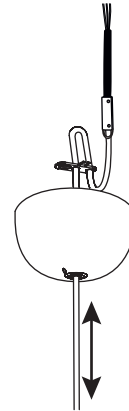

3



4

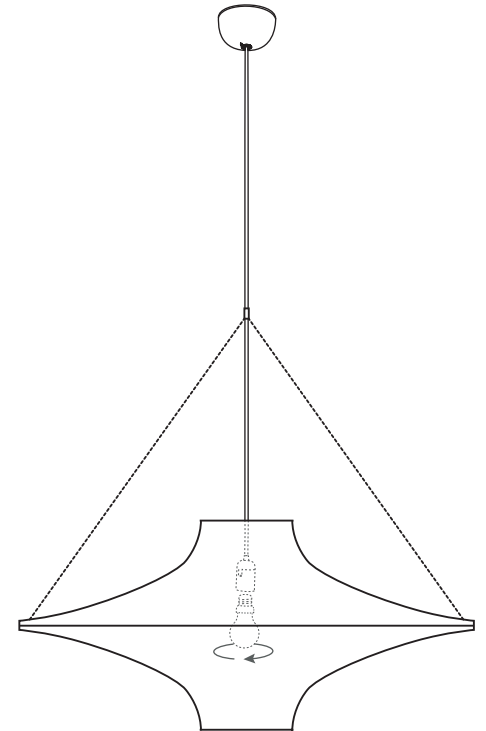
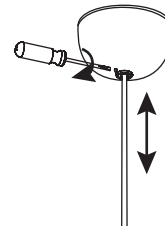

(A) Roof socket:

1

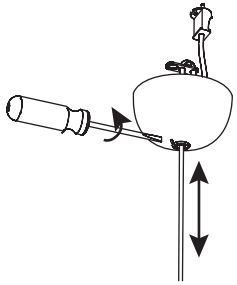

2

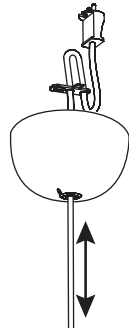

3

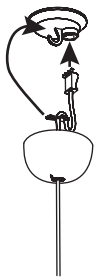

4

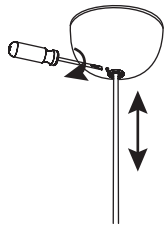

(B) No roof socket:

1

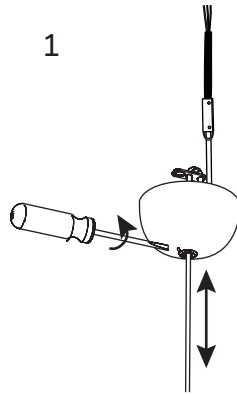

2

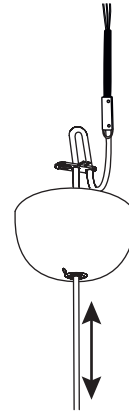

3



4

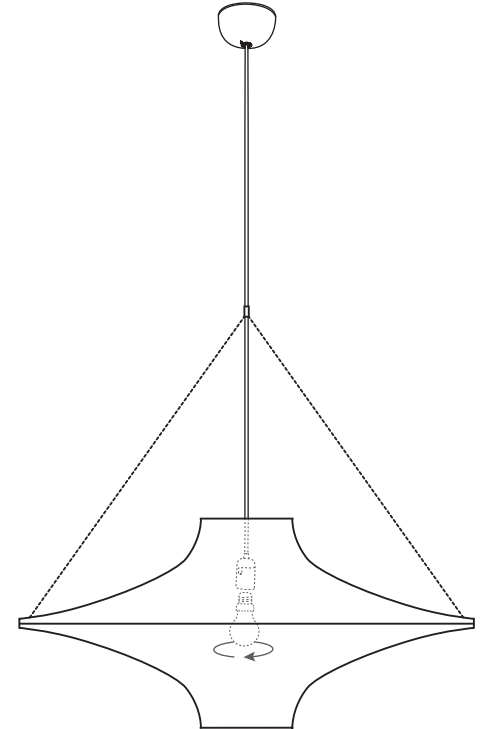
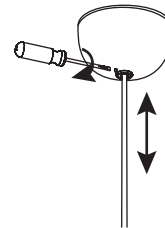





LOKKI 700



Installation instructions
V.14A

Osat:

2 x Lampshade

Suspension set supplies:

- 1 x Cord 
- 1 x Ceiling plug cord 
- 1 x Ceiling-rose 
- 1 x Bead chain bag 

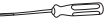
- 1 x Cord-strain 
- 1 x Rubber sleeve, two poles terminal block 
- 1 x Screwdriver 

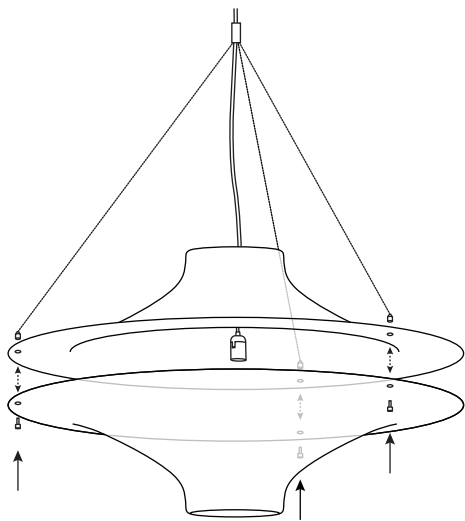

1 Place the shades together so that holes align. Open the bead chain screws and insert the screws through the holes underneath the shade.

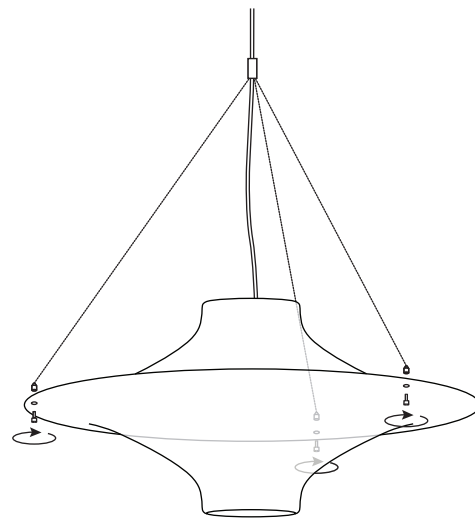

2 Tighten the screws with their counterparts above the lampshade. Check that the bead chains are in order. Hold lampshades together to get the screws are firmly tight.

INNOLUX
design Yki Nummi

A Roof socket:

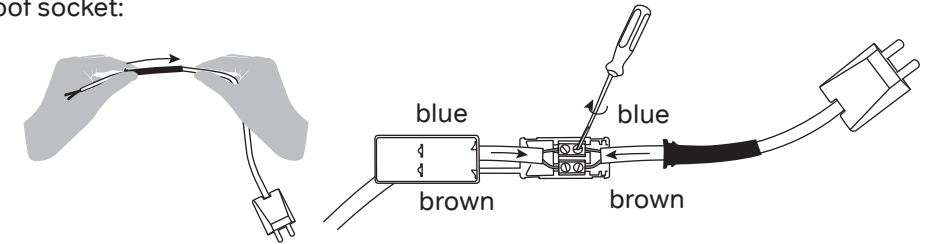

3 Insert the ceiling plug cord through the rubber sleeve.

4 Open the screws of two poles terminal block, insert the ends of the cords in their places and tighten the screws firmly.

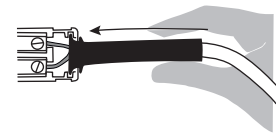

5 Move the rubber sleeve to its place.

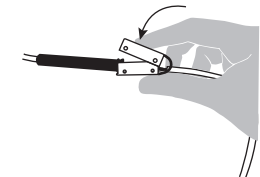

6 Close the cover so that all four staples click.

B No roof socket:

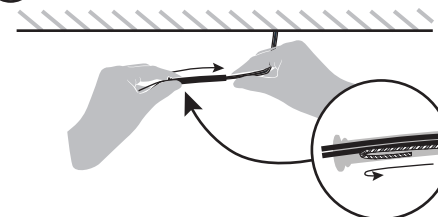

3 Fold the yellowgreen ceiling wire and insert all the ceiling wires through the rubber sleeve.

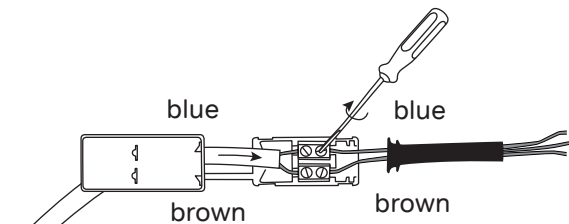

4 Open the screws of two poles terminal block, insert the ends of the cord and the ceiling wires (not the yellowgreen wire) in their places and tighten the screws firmly.

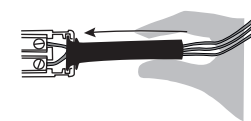

5 Move the rubber sleeve to its place.

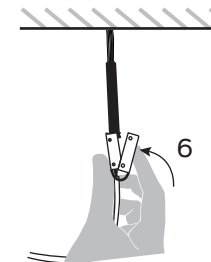

6 Close the cover so that all four staples click.

INNOLUX
Home of good light.